

Eco Preparation 1400 mm Work Table with Upstand - disassembled

ITEM # _____

MODEL # _____

NAME # _____

SIS # _____

AIA # _____



132847 (WTD1417N)

 Work Table disassembled
 with upstand, 1400mm

Short Form Specification

Item No. _____

Worktop in 304 AISI stainless steel with upturned edges and under panel made of sound deadening material. Rear upstand h=100mm. Square section legs 40x40mm in 304 AISI stainless steel with adjustable feet. Delivered disassembled.

Main Features

- The table can be ordered with the drawer of 400 mm or 600 mm (optional accessory): thanks to the design of the drawer, additional drawers can be added to the first single drawer to create chest of 2, 3 or 4 drawers based on customer's needs.
- Sturdiness, stability and reliability of table accurately tested.

Construction

- Delivered in knock-down package.
- Constructed entirely in stainless steel to offer maximum durability.
- Wide range of taps are available to suit every need.

Optional Accessories

- Lower shelf for 1400mm tables and sinks PNC 855146
- Set of 4 wheels (2 with brake) d. 100mm for tables and sinks (total height on wheels= 993 mm) PNC 855150
- 3-sided underframe for 1400mm tables PNC 855153

APPROVAL: _____

Key Information:

External dimensions, Width:	1400 mm
132847 (WTD1417N)	
External dimensions, Depth:	700 mm
External dimensions, Height:	900 mm
Worktop thickness:	50 mm
Worktop/Shelf radius:	90°
Net weight:	47 kg

Front

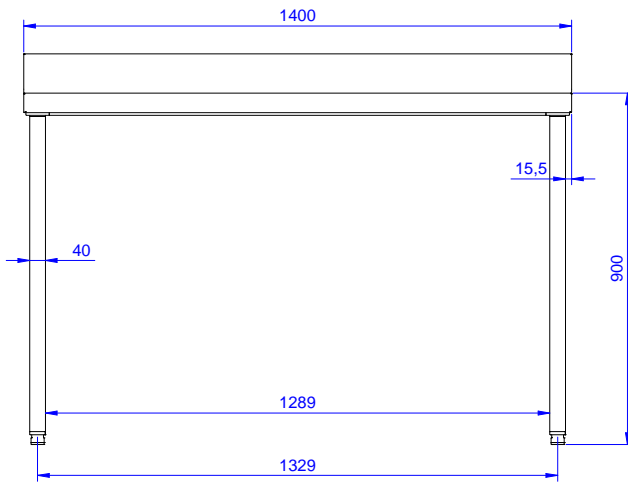

Side

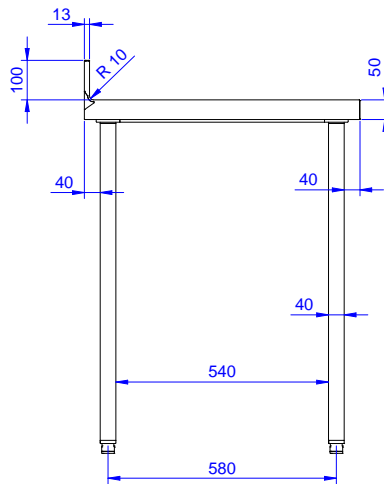

Top

